

WARMING & TRENDS[®]

SUPERIOR FIRE FEATURE SYSTEMS



SCAN TO VISIT US AT
WARMING-TRENDS.COM



FEBRUARY 2026

PATENTED
www.warming-trends.com/patents

WARMING TRENDS®

SUPERIOR DESIGN. SUPERIOR PERFORMANCE.
SUPERIOR FIRE FEATURE SYSTEMS.



Competitor Burner with 180K BTUs



U180 CROSSFIRE® 2.0 Brass Burner with 180K BTUs

WE DIDN'T INVENT FIRE. WE **PERFECTED** IT.

Warming Trends transformed the outdoor fire industry with the invention of the patented CROSSFIRE® Brass Burner, the benchmark for performance, durability, and efficiency. Today, every Warming Trends product is built on that same legacy of innovation, delivering taller, brighter flames with less fuel.

Designed, engineered, and assembled in the USA, our systems combine uncompromising craftsmanship with advanced ignition technology and industry-leading reliability. The result is luxury fire features you can trust, backed by exceptional service and decades of expertise.



AON FIRE TABLE COLLECTIONS
PAGE 4-7

Beautiful powder-coated fire tables designed to stand out as an elegant, timeless addition to any outdoor living space.



AON ARCHITECTURAL VESSELS
PAGE 8-11

These metal or GFRC vessels offer an excellent option when looking for a smaller feature to add elegance to an outdoor design.



READY-TO-FINISH KITS
PAGE 12

An aluminum frame covered with concrete board arrives on-site ready to be completed with your choice of stone or veneer.



OUTDOOR FIREPLACE COLLECTION
PAGE 13

Elegant kits designed to easily complete a beautiful gas-fueled outdoor fireplace.

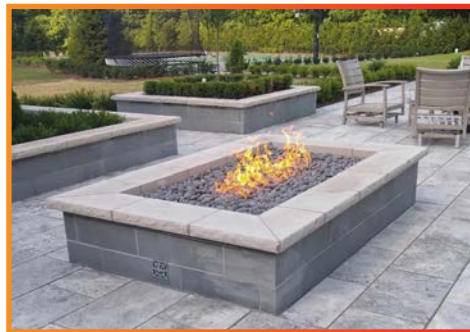

UNIVERSAL GAS INSERT KITS
PAGE 14

Easily and quickly convert a new or existing paver fire feature to gas with our Gas Insert Kits.

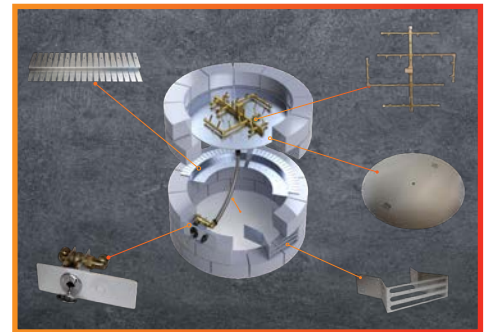

SPECIALIZED GAS INSERT KITS
PAGE 15

No cutting or drilling is needed with Gas Insert Kits designed to fit many popular paver fire pits.



CROSSFIRE 2.0 BURNERS
PAGE 16-17

Choose from a variety of burners that work universally with natural gas and liquid propane, delivering outstanding flame performance and fuel efficiency.



IGNITION SYSTEMS
PAGE 18

Choose from a premium selection of ignition systems to complement any fire feature or location.

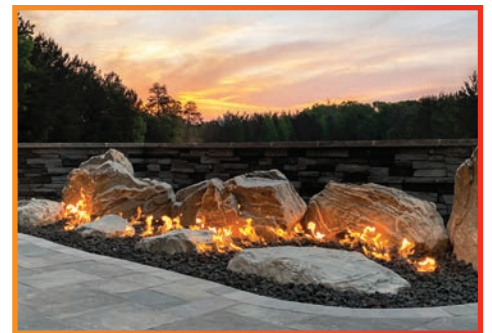

CUSTOM FIRE FEATURES
PAGE 19

If you can dream it, we can make it. Let us help you create the perfect fire feature for your next project.





AON FIRE TABLE COLLECTION



Beautiful powder-coated, metal **AON FIRE TABLES** are designed to stand out as an elegant, timeless addition to any outdoor living space. These tables are expertly engineered for outstanding durability and performance. Color options include Black, Dark Bronze, Charcoal, Deep Blue, and Sand Pebble. Proudly engineered, designed, and assembled in the United States.

FEATURES

- **CROSSFIRE® 2.0 Burner with WATERSTOP® fitting** protects gas line and valve box from water and debris
- Standard push-button ignition (see upgrade options starting on page 18)
- Recessed Control Box
- Included Flush Cover provides for a smooth "table top" when not in use
- Detachable faceplate and lift-out pan provide for easy installation and maintenance
- Adjustable, leveling feet
- Inset Toe Kick

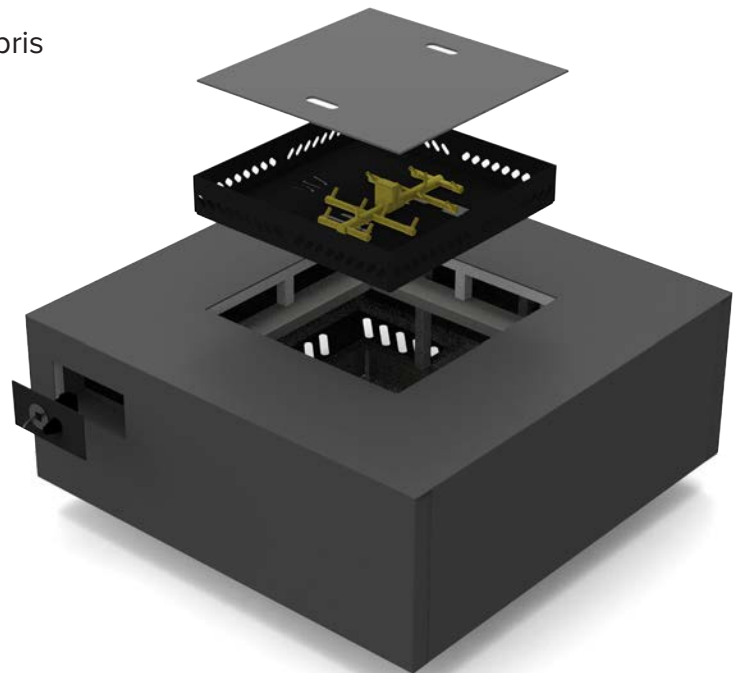

SQUARE FIRE TABLES

40" Square	40" x 40" x 18" Square AON Fire Table • 140,000 BTU CROSSFIRE® Burner with WATERSTOP® • 20" Square Ventilated Pan • 10" Top Ledge • Push Button Ignition System
48" Square	48" x 48" x 18" Square AON Fire Table • 180,000 BTU CROSSFIRE® Burner with WATERSTOP® • 28" Square Ventilated Pan • 10" Top Ledge • Push Button Ignition System
56" Square	56" x 56" x 18" Square AON Fire Table • 280,000 BTU CROSSFIRE® Burner with WATERSTOP® • 36" Square Ventilated Pan • 10" Top Ledge • Push Button Ignition System

RECTANGULAR FIRE TABLES

48" Rectangular	48" x 30" x 18" Rectangular AON Fire Table • 170,000 BTU CROSSFIRE® Burner with WATERSTOP® • 28" x 10" Rectangular Ventilated Pan • 10" Top Ledge • Push Button Ignition System
60" Rectangular	60" x 34" x 18" Rectangular AON Fire Table • 230,000 BTU CROSSFIRE® Burner with WATERSTOP® • 40" x 14" Rectangular Ventilated Pan • 10" Top Ledge • Push Button Ignition System
72" Rectangular	72" x 38" x 18" Rectangular AON Fire Table • 290,000 BTU CROSSFIRE® Burner with WATERSTOP® • 52" x 18" Rectangular Ventilated Pan • 10" Top Ledge • Push Button Ignition System

CIRCULAR FIRE TABLES

36" Circular	36" x 18" Circular AON Fire Table • 120,000 BTU CROSSFIRE® Burner with WATERSTOP® • 18" Circular Ventilated Pan • 9" Top Ledge • Push Button Ignition System
42" Circular	42" x 18" Circular AON Fire Table • 140,000 BTU CROSSFIRE® Burner with WATERSTOP® • 22" Circular Ventilated Pan • 10" Top Ledge • Push Button Ignition System
48" Circular	48" x 18" Circular AON Fire Table • 180,000 BTU CROSSFIRE® Burner with WATERSTOP® • 28" Circular Ventilated Pan • 10" Top Ledge • Push Button Ignition System

COLOR OPTIONS

Request a color sample by emailing orders@warming-trends.com or by calling (303) 346-2224. Actual colors may vary from images.

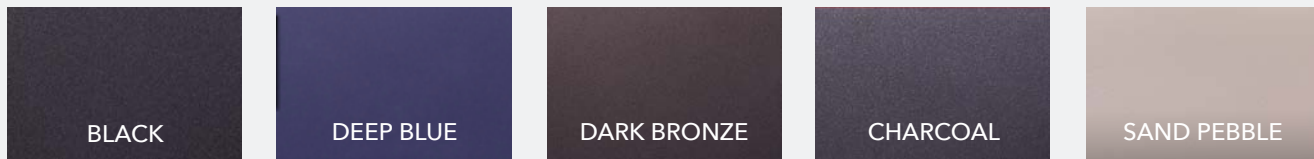

IGNITE WITH CONFIDENCE

When coupled with the WATERSTOP® fitting standard on universal CROSSFIRE® 2.0 burners, the addition of a Cobalt Low Voltage Ignition System™ delivers unmatched reliability, convenience, and adherence to building and safety codes. Ideal for installations around pools, spas or other water features.



We offer a range of ignition upgrades to compliment your project needs. **See page 18.**

Cobalt Low Voltage Ignition System™, Carbon Low Voltage Ignition System™, Mercury Ignition System™ and Platinum Ignition System™ are trademarks owned by and used with permission from Catalyst Electronics, LLC.



AON

CAPSTONE COLLECTION

AON CAPSTONE FIRE TABLE



The **AON CAPSTONE FIRE TABLE** is a modern architectural fire feature designed to anchor high-end outdoor spaces with clean lines and premium materials. A combination of an impressive GFRC capstone and a beautiful powder-coated aluminum base results in a unique feature that truly reflects your personal design aesthetic. Choose from an extensive selection of colors and finishes. Scan above for our complete offering.

FEATURES

- **CROSSFIRE® 2.0 Burner with WATERSTOP® fitting** protects gas line and valve box from water and debris
- Standard push-button ignition (see upgrade options starting on page 18)
- Recessed Control Box
- Detachable faceplate and lift-out pan provide for easy installation and maintenance
- Adjustable, leveling feet
- Optional aluminum cover available



RECTANGULAR FIRE TABLES

OVERALL TABLE DIMENSIONS	DESCRIPTION
56"L x 34"W Overall Size	40"L x 22"W x 17 ¾"H Rectangular Aluminum Base with a 56"L x 34"W x 3"H GFRC Top • 170,000 BTU CROSSFIRE® Burner with WATERSTOP® • 28"L x 10"W Burner Opening • Push Button Ignition System
72"L x 42"W Overall Size	48"L x 30"W x 17 ¾"H Rectangular Aluminum Base with a 72"L x 42"W x 3"H GFRC Top • 170,000 BTU CROSSFIRE® Burner with WATERSTOP® • 28"L x 10"W Burner Opening • Push Button Ignition System
84"L x 42"W Overall Size	60"L x 30"W x 17 ¾"H Rectangular Aluminum Base with a 84"L x 42"W x 3"H GFRC Top • 290,000 BTU CROSSFIRE® Burner with WATERSTOP® • 49"L x 14"W Burner Opening • Push Button Ignition System

COLOR OPTIONS

Select your size and then one base color and one tabletop color to complete your custom Capstone table. Color samples may be ordered by emailing orders@warming-trends.com or by calling (303) 346-2224. Actual colors may vary from images.

BASE COLOR OPTIONS



TABLETOP COLOR OPTIONS

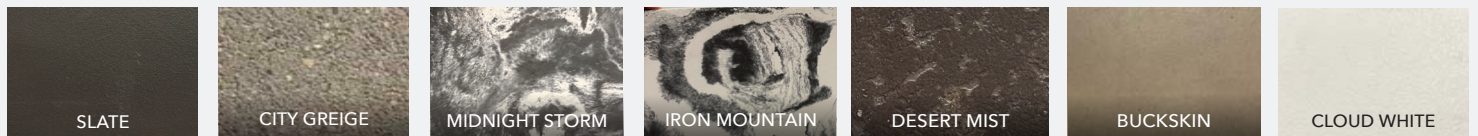

20 LB PROPANE TANK COVERS

Available in matching base color options.



IGNITION UPGRADE OPTIONS

Whether for convenience, safety or building codes, ignition upgrades are available. When coupled with Warming Trends' proprietary WATERSTOP® fitting, our ignition systems deliver unmatched reliability.

See page 18.

Cobalt Low Voltage Ignition System™, Carbon Low Voltage Ignition System™, Mercury Ignition System™ and Platinum Ignition System™ are trademarks owned by and used with permission from Catalyst Electronics, LLC.





AON ARCHITECTURAL CONCRETE VESSELS



Beautifully engineered from lightweight GFRC (Glass Fiber Reinforced Concrete), **AON ARCHITECTURAL CONCRETE VESSELS** combine sophisticated design with exceptional durability to deliver high-end impact without the weight of traditional concrete. An excellent option when looking to add a unique fire element to any outdoor design.

FEATURES

- **CROSSFIRE® 2.0** Burner with **WATERSTOP®** fitting protects gas line and valve box from water and debris.
- The look of traditional concrete at a fraction of the weight. Easier to handle, ship, and install.
- Four designer colors to match any aesthetic.
- Comes standard match-lit. Pair with the Cobalt Low Voltage Ignition System for the ultimate in convenience.

COLOR OPTIONS

Request a color sample by emailing orders@warming-trends.com or by calling (303) 346-2224. Actual colors may vary from images.

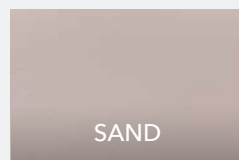
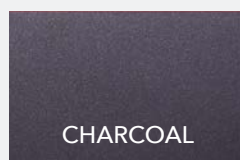
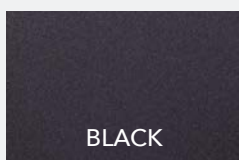



Aura (Bowl)

SIZE	DESCRIPTION
SMALL	26" W x 8 1/2" H • U100 Burner • 48" x 1/2" Flex Line + 1/2" Key Valve
MEDIUM	32" W x 10 1/2" H • U100 Burner • 48" x 1/2" Flex Line + 1/2" Key Valve
LARGE	37 1/2" W x 14" H • U140 Burner • 48" x 1/2" Flex Line + 1/2" Key Valve



Halo (Round Wok)

SIZE	DESCRIPTION
SMALL	24" W x 8 1/2" H • U100 Burner • 48" x 1/2" Flex Line + 1/2" Key Valve
MEDIUM	31" W x 11" H • U100 Burner • 48" x 1/2" Flex Line + 1/2" Key Valve
LARGE	38 1/2" W x 14 3/4" H • U140 Burner • 48" x 1/2" Flex Line + 1/2" Key Valve



Ember (Square Wok)

SIZE	DESCRIPTION
SMALL	24" W x 24" L x 12" H • U100 Burner • 48" x 1/2" Flex Line + 1/2" Key Valve
MEDIUM	31" W x 31" L x 10" H • U100 Burner • 48" x 1/2" Flex Line + 1/2" Key Valve
LARGE	41 3/4" W x 41 3/4" L x 16 1/4" H • U140 Burner • 48" x 1/2" Flex Line + 1/2" Key Valve

IGNITE WITH CONFIDENCE

When coupled with the WATERSTOP® fitting standard on universal CROSSFIRE® 2.0 burners, the addition of a Cobalt Low Voltage Ignition System™ delivers unmatched reliability, convenience, and adherence to building and safety codes. Ideal for installations around pools, spas or other water features.



We offer a range of ignition upgrades to compliment your project needs. **See page 18.**

Cobalt Low Voltage Ignition System™, Carbon Low Voltage Ignition System™, Mercury Ignition System™ and Platinum Ignition System™ are trademarks owned by and used with permission from Catalyst Electronics, LLC.



AON ARCHITECTURAL METAL VESSELS



AON ARCHITECTURAL METAL VESSELS offer a distinct alternative to cast fire features. Their sleek profile and refined finish deliver a modern, architectural look while maintaining exceptional strength and long-term performance outdoors.

FEATURES

- **CROSSFIRE® 2.0** Burner with **WATERSTOP®** fitting protects gas line and valve box from water and debris.
- Material stability in outdoor environments, minimizing concerns related to moisture exposure, surface wear, and seasonal conditions.
- Four designer colors to match any aesthetic.
- Comes standard match-lit. Pair with the Cobalt Low Voltage Ignition System for the ultimate in convenience.

COLOR OPTIONS

Request a color sample by emailing orders@warming-trends.com or by calling (303) 346-2224. Actual colors may vary from images.

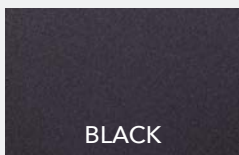

BLACK

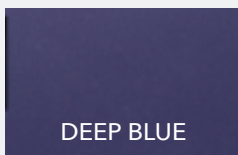

DEEP BLUE

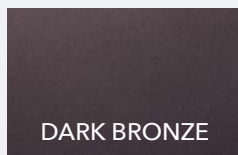

DARK BRONZE

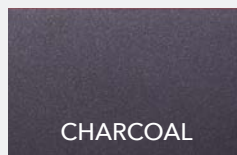

CHARCOAL

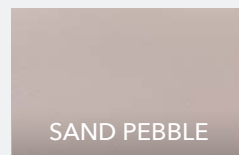

SAND PEBBLE



Ascend (Round Wok)

SIZE	DESCRIPTION
SMALL	24" W x 24" L x 10" H • U100 Burner • 48" x 1/2" Flex Line + 1/2" Key Valve
LARGE	30" W x 30" L x 10" H • U100 Burner • 48" x 1/2" Flex Line + 1/2" Key Valve



Pinnacle (Square Wok)

SIZE	DESCRIPTION
SMALL	24" W x 24" L x 10" H • U100 Burner • 48" x 1/2" Flex Line + 1/2" Key Valve
LARGE	30" W x 30" L x 10" H • U100 Burner • 48" x 1/2" Flex Line + 1/2" Key Valve



IGNITE WITH CONFIDENCE

When coupled with the WATERSTOP® fitting standard on universal CROSSFIRE® 2.0 burners, the addition of a Cobalt Low Voltage Ignition System™ delivers unmatched reliability, convenience, and adherence to building and safety codes. Ideal for installations around pools, spas or other water features.



We offer a range of ignition upgrades to compliment your project needs. **See page 18.**

Cobalt Low Voltage Ignition System™, Carbon Low Voltage Ignition System™, Mercury Ignition System™ and Platinum Ignition System™ are trademarks owned by and used with permission from Catalyst Electronics, LLC.

READY-TO-FINISH COLLECTION



READY-TO-FINISH KITS



These fire features are made with aluminum frames, covered with durable concrete boards, and are ready to be easily completed on site. Just place it, connect to the gas supply, add your choice of stone or other veneer and your personalized fire feature is complete. Available in a range of sizes and shapes as well as custom designs to meet your project's needs.

INCLUDED IN EACH READY-TO-FINISH KIT

- CROSSFIRE® 2.0 Brass Burner with WATERSTOP® fitting
- Aluminum pan
- Flex Line / Key Valve Kit
- Fire Pit Vent Kit - The two included vents are not pre-installed as placement and installation depends on the veneer. Vents are to be installed by contractor on-site.

READY-TO-FINISH KITS COME WITH A FIRE PIT VENT KIT (FPVK)

But they do not come pre-installed as placement and installation depends on veneer. Vents are to be installed by the contractor on site.
See **Dealer Catalog page 29** for format.

OUTDOOR FIREPLACE COLLECTION



OUTDOOR FIREPLACE COLLECTION



The **OUTDOOR FIREPLACE COLLECTION** (OFC) by Warming Trends® offers elegant kits designed to easily complete a beautiful gas-fueled outdoor fireplace.

Determine the correct size kit based on the interior width and depth of your fireplace. Choose between an H-Style or Tree-Style **CROSSFIRE**® 2.0 Brass Burner to complete your kit.

Whether your project includes a small, medium, large, or extra-large outdoor fireplace, Warming Trends has you covered.

INCLUDED IN EACH OUTDOOR FIREPLACE KIT

- Steel log grate*
- **CROSSFIRE**® 2.0 Brass Burner + **WATERSTOP**® strapped to an elevated black powder-coated aluminum plate
- 3 inch key, 12 inch key, and 8 inch key valve extension
- Push button ignition kit and faceplate
- 65K and 90K reducing orifice

* Logs Not Included

GAS INSERT KITS for PAVER FIRE FEATURES



Warming Trends makes it easy to install or convert a paver fire pit to gas with our **UNIVERSAL GAS INSERT KITS**. Each Universal Kit comes complete with everything needed to install or convert a paver block feature to gas. Available in a variety of shapes and sizes.

INCLUDED IN EACH KIT:

- CROSSFIRE® 2.0 Brass Burner with WATERSTOP® fitting
- Aluminum plate
- Flex Line / Key Valve Kit
- 4" x 8" adjustable mounting bracket
- Flexible metal support collars and Tapcon screws (works with new or existing fire pit)

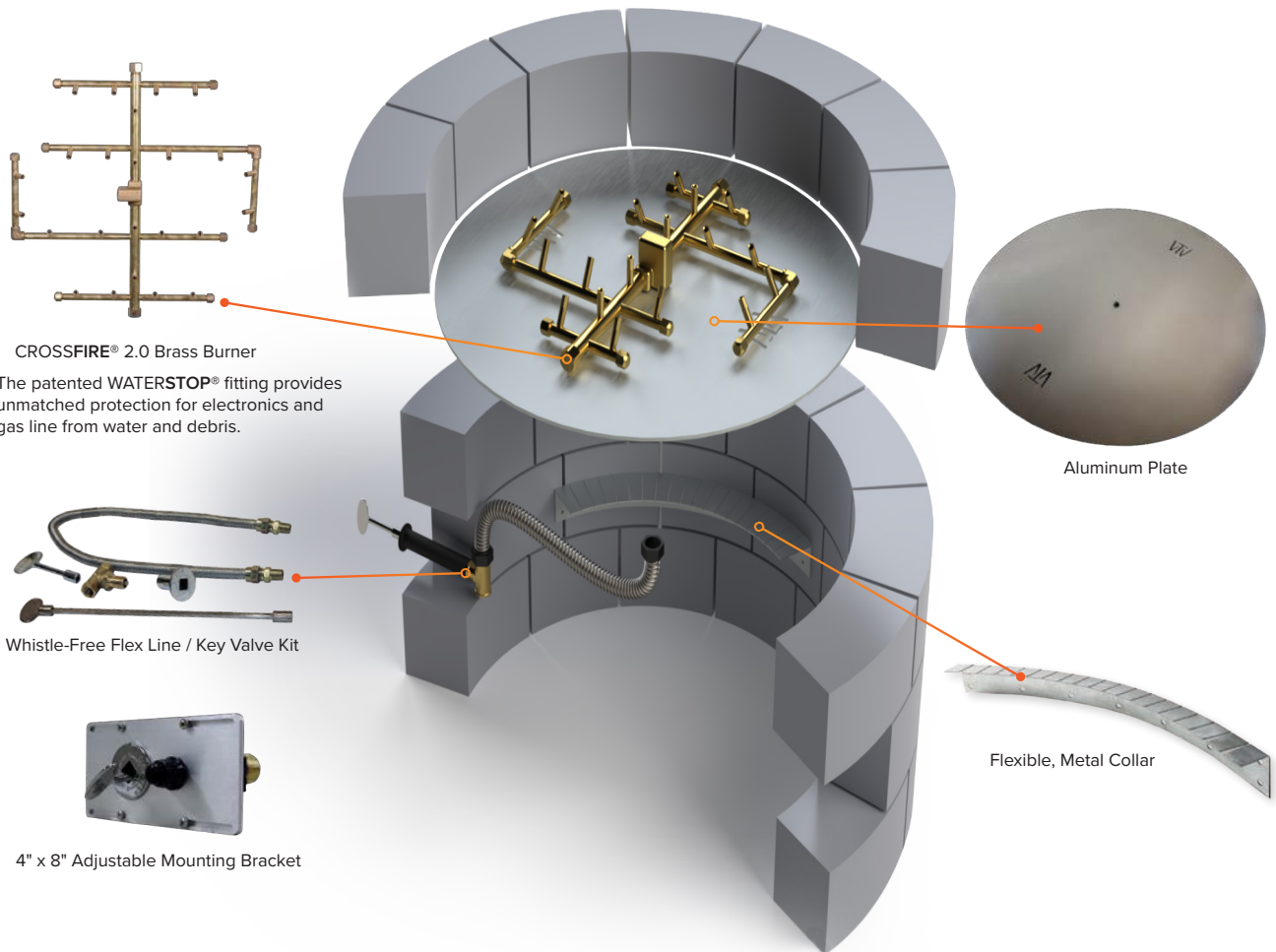

CROSSFIRE® 2.0 Brass Burner

The patented WATERSTOP® fitting provides unmatched protection for electronics and gas line from water and debris.

Aluminum Plate

Whistle-Free Flex Line / Key Valve Kit

Flexible, Metal Collar

4" x 8" Adjustable Mounting Bracket

*Universal Paver Kits work with a variety of paver company block kits.

KIT DOES NOT INCLUDE STONE / ENCLOSURE OR VENTS.

Manufacturer recommends 18 square inches of ventilation on opposing sides of the fire feature. Collars provide support for the aluminum plate and allow a range of plate sizes to be used, adding up to 3" to the plate size.

If you do not see the specific kit you are looking for, please contact our **Flame Specialists** at orders@warming-trends.com or call **(303) 346-2224**.

BESPOKE GAS INSERT KITS

for PAVER FIRE FEATURES



The **SPECIALIZED GAS INSERT KITS** fit top-selling paver fire pit brands and are easier to install than ever before! The mounting brackets and collars have been engineered for a perfect fit, eliminating the need for a drilling or sawing to install. Each kit includes all components to create an exceptional fire feature.

INCLUDED IN EACH KIT:

- CROSSFIRE® 2.0 Brass Burner with WATERSTOP® fitting
- Aluminum plate
- Flex Line / Key Valve Kit
- Flexible, no-drill collars
- Vents (2)
- Mounting bracket

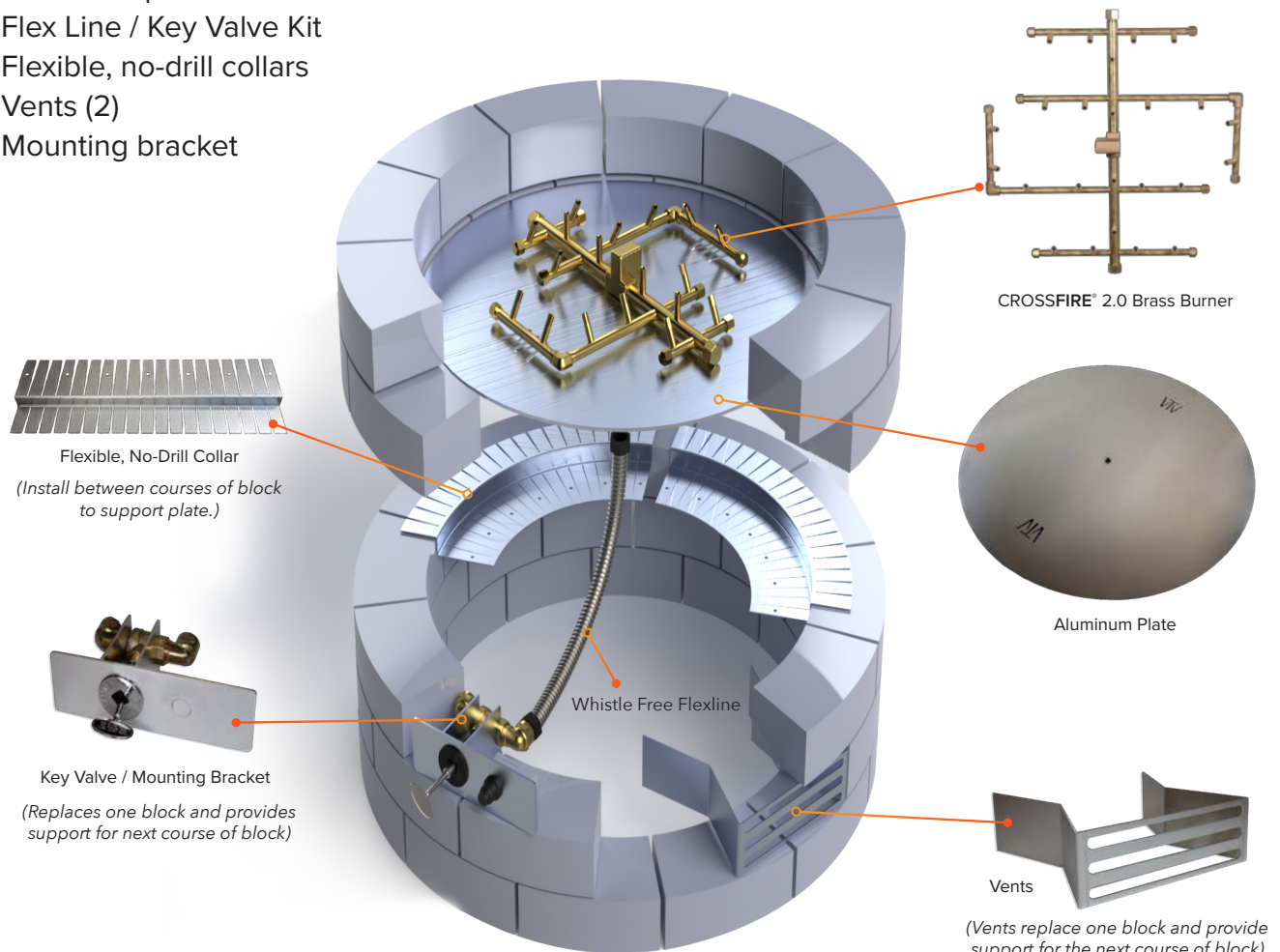

Flexible, No-Drill Collar
(Install between courses of block to support plate.)



Key Valve / Mounting Bracket
(Replaces one block and provides support for next course of block)



CROSSFIRE® 2.0 Brass Burner

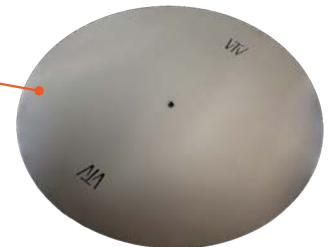

Aluminum Plate

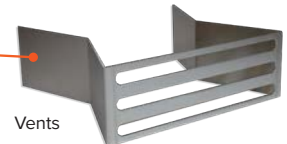

Vents
(Vents replace one block and provide support for the next course of block)

KIT DOES NOT INCLUDE PAVERS.

Collars provide support for the aluminum plate and allow a range of plate sizes to be used, adding up to 3" to the plate size.

For the list of complete Gas Insert Kits, please visit us at www.warming-trends.com/paverkits.

UNIVERSAL BURNER OPTIONS FOR... **SQUARE** and **CIRCULAR OPENINGS**



All Warming Trends burner systems are "universal" and accommodate either LP (liquid propane) or NG (natural gas). Customers do not need to specify gas type when purchasing a burner system. Any orders for ignition systems do require gas type specification. Designed for standard-sized circular or square fire features, these **CROSSFIRE® 2.0 BRASS BURNERS** range from 60K to 560K BTUs.

NEED A DIFFERENT SIZE, CUSTOM SHAPE, OR HAVE BTU QUESTIONS?

Whatever your question, our team is happy to help. Call our Flame Specialists at (303) 346-2224.

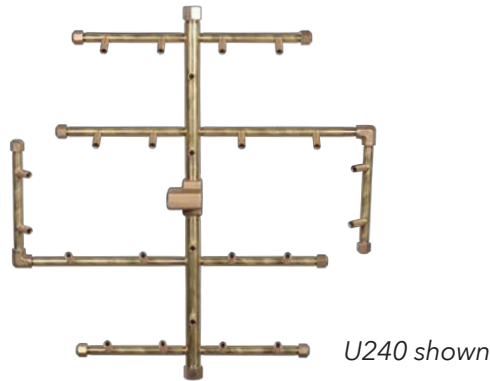

The new pinwheel design works seamlessly with both Circular and Square features, delivering improved plate performance and a more efficient footprint.

SEE PAGE 18 FOR AVAILABLE COMPATIBLE IGNITION SYSTEMS



UNIVERSAL BURNER OPTIONS FOR...

RECTANGULAR FIRE FEATURES and OUTDOOR FIREPLACES



Designed for standard-sized rectangular fire features, these **CROSSFIRE® 2.0 BRASS BURNERS** range from 90K to 480K BTUs.

NEED A DIFFERENT SIZE, CUSTOM SHAPE, OR HAVE BTU QUESTIONS?

Whatever your question, our team is happy to help. Call our Flame Specialists at (303) 346-2224.

LINEAR



H-STYLE



TREE-STYLE

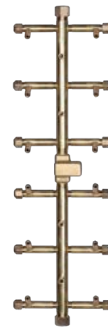

SEE PAGE 18 FOR AVAILABLE COMPATIBLE IGNITION SYSTEMS



IGNITION SYSTEMS



IGNITION SYSTEMS



Whether for personal convenience to meet building / safety codes, we have a range of ignition systems to fit your needs.



MERCURY IGNITION SYSTEM™

Delivers an outstanding 240,000 BTUs of gas output at a remarkable price. No electricity required. Safety shut off.



COBALT LOW VOLTAGE IGNITION SYSTEM™

Ideal for installations near pools, spas, or other water features. 490,000 BTU output, 12 volt system and meets National Standards for low voltage applications.



CARBON LOW VOLTAGE IGNITION SYSTEM™

Fully automatic low-voltage ignition system with dual power options (direct wire or easy-access D-Cell batteries). Ideal for installations near pools, spas, or other water features. 360,000 BTU output. Meets National Standards for low voltage applications.



PLATINUM IGNITION SYSTEM™

24V electronic system with 680,000 BTU delivery. Innovative, robust design and coupled with the WATERSTOP® fitting, the Platinum Ignition System™ delivers unmatched reliability.



PUSH BUTTON IGNITION

The same as a grill igniter, the Push Button Ignition is simple to operate and cost-effective.

Carbon Low Voltage Ignition System™, Cobalt Low Voltage Ignition System™, Mercury Ignition System™, and Platinum Ignition System™ are trademarks owned by and used with permission from Catalyst Electronics, LLC.

CUSTOM FIRE FEATURES



CUSTOM FIRE FEATURES



IF YOU CAN DREAM IT, WE CAN BUILD IT.

Custom designs can range from something simple (e.g., a longer version of a standard linear burner) to very complex (e.g., burners to fit a vertical feature). The vision might include a unique install, such as in-ground or at the edge of a pool.

No matter the concept, creating your next custom fire feature doesn't have to be complicated. Any vision can easily become a reality with Warming Trends' design expertise and unmatched manufacturing capabilities.

WARMING & TRENDS®

THE ONLY SOLUTION FOR AN INDUSTRY-WIDE STRUGGLE

Most systems leave the manifold vulnerable to water intrusion, risking expensive damage. The WATERSTOP® fitting eliminates that risk.

STANDARD ON EVERY BURNER

The patented WATERSTOP® fitting comes standard on every CROSSFIRE® 2.0 burner.

ONLY FROM WARMING TRENDS®

The WATERSTOP® fitting ensures outstanding flame performance by automatically purging any water from the manifold when ignited.

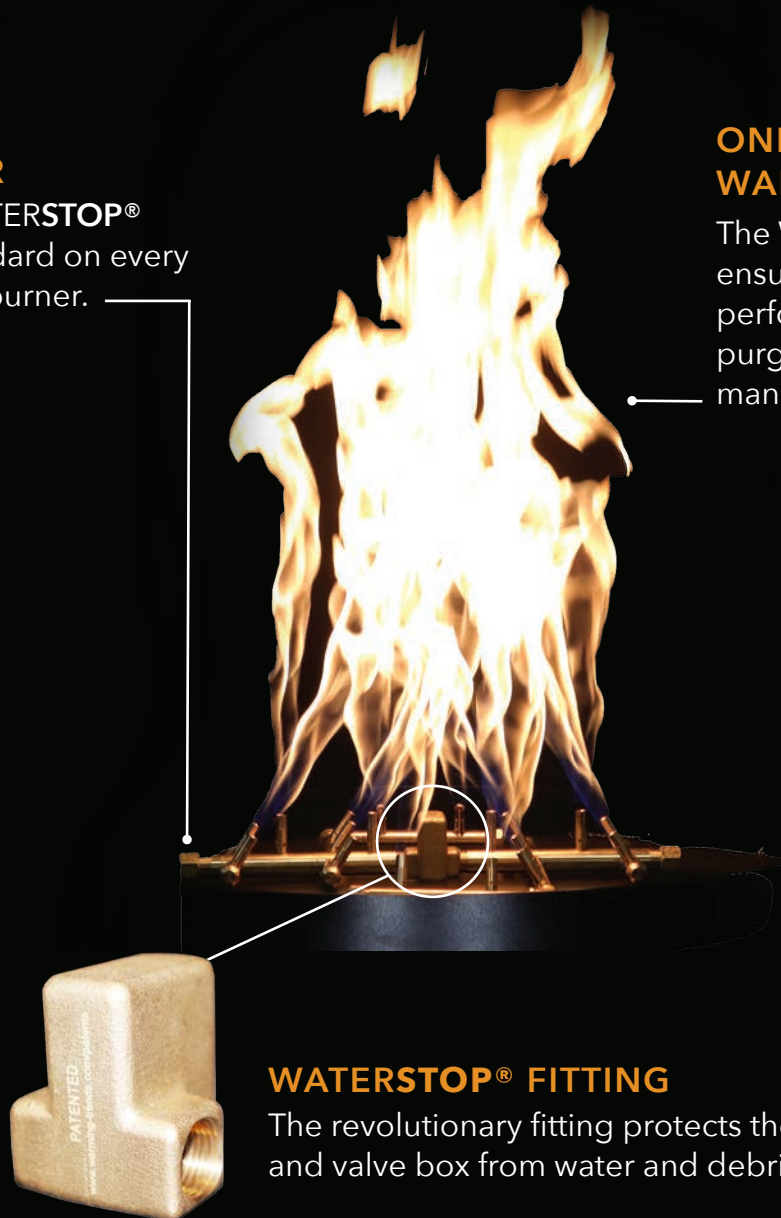

WATERSTOP® FITTING

The revolutionary fitting protects the gas lines and valve box from water and debris.

CONTACT US

(303) 346 - 2224

Orders@Warming-Trends.com

SCAN TO VISIT US AT

WARMING-TRENDS.COM



PATENTED

www.warming-trends.com/patents